

Turbine Ventilator with Adjustable Base

INSTALLATION INSTRUCTIONS

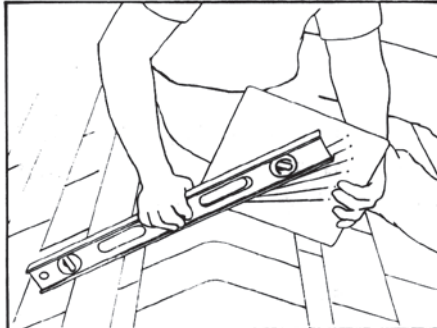

To determine roof pitch, stand pitch gauge on peak of roof. Place straight edge on opposite side of roof. Read roof pitch from printed gauge parallel to bottom of straight edge.

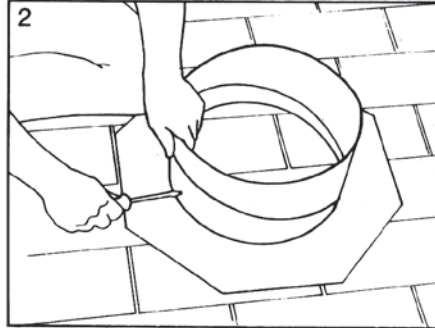

Turn bottom of collar clockwise to match roof pitch number with indicator line on flashing. Place 3 (#10) sheet metal screws through holes that align with predrilled base holes.

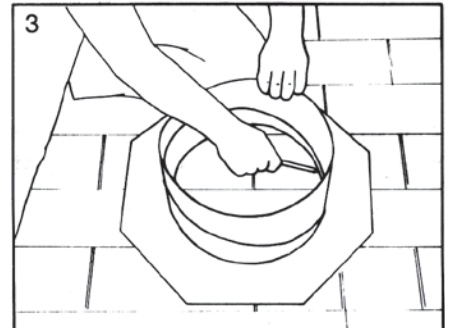

Choose location of turbine by using back of this page. Center between two rafters and mark hole to be cut.

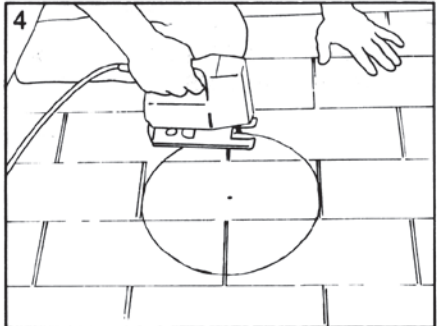

Cut hole as marked and seal around top and sides with roofing cement.

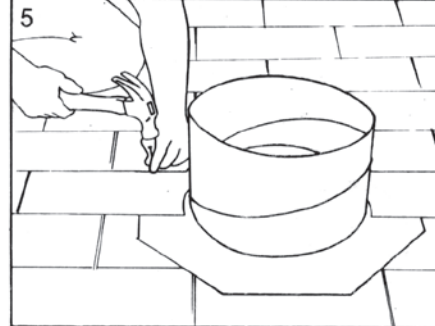

Slide top half of flashing under shingles all the way to the collar. Apply 1/2" bead of caulk between the roof deck and the bottom face of the vent flange. Secure with (12) 1-1/4" x 3/8" galvanized ring shank nails.

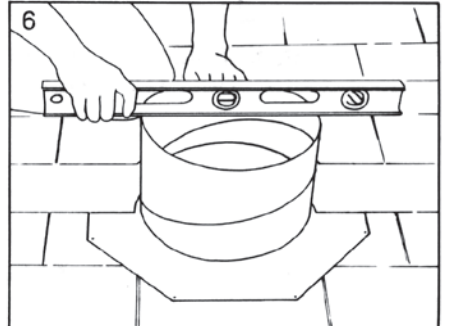

Turn top of collar counter clockwise to a level position.

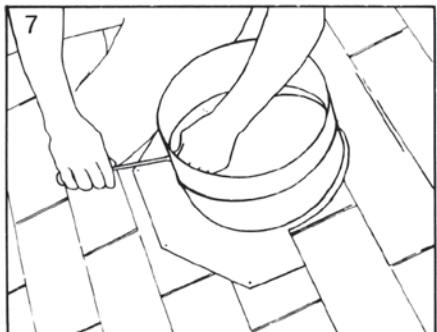

Place locking clamp across seam and tighten with color-coded machine screw.

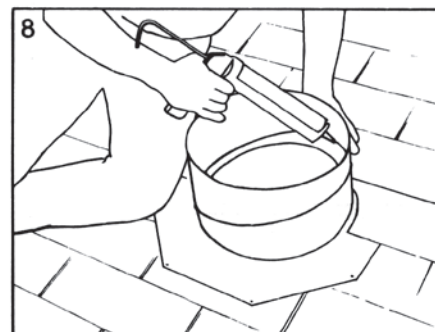

Using caulk, fasten down any loose shingles. Using caulk, seal all seams and nails.

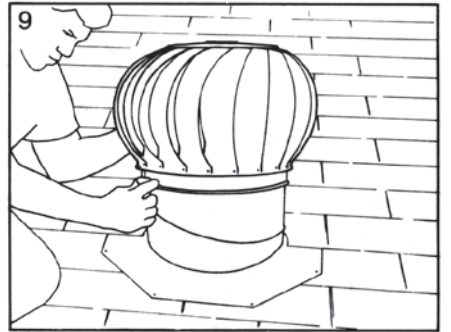

Position turbine onto the collar, locating the vertical legs into the collar slots. Install #10 x 1" sheet metal screws through the vertical legs and into the extruded holes in the collar. Tighten the screws firmly, but do not over-tighten to the point that the screw strips out.

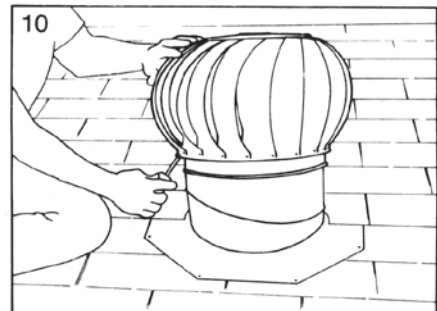

After completing installation, check to make sure the turbine turns freely. The turbine may have shifted in transportation. If necessary, gently pry lowest point of turbine upward to remove any wobble.

TOOLS YOU NEED

Phillips Screwdriver	Carpenter's Level
Putty Knife	Keyhole or Sabre Saw
Utility Knife	Hammer
Drill	Ruler

Le Ventilateur de Turbine avec Base Ajustable

INSTRUCTIONS D'INSTALLATION

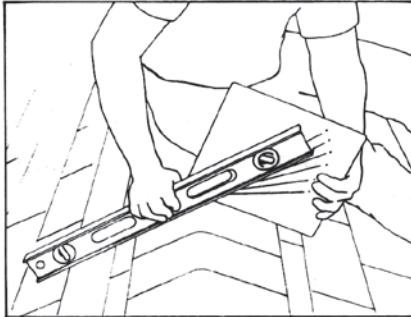

Pour déterminer l'inclinaison du toit, posez la jauge d'inclinaison sur l'arête du toit. Placez le bord droit sur le côté opposé du toit. Lisez l'inclinaison du toit de la jauge imprimée, parallèle au bas du bord droit.

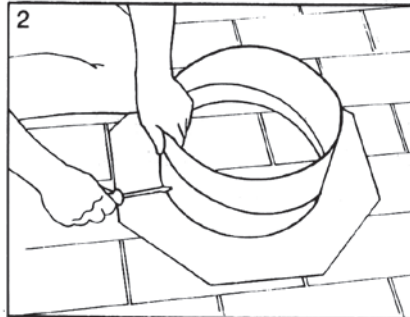

Tournez le bas du collier dans le sens des aiguilles d'une montre, pour accorder le numéro d'inclinaison du toit avec la ligne de l'indicateur sur le solin. Placez 3 (#10) vis à travers les trous qui s'alignent avec les trous de base percés d'avance.

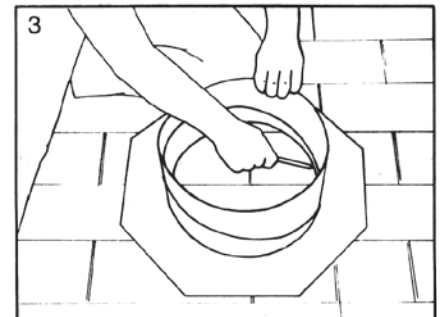

Choisissez l'emplacement de la turbine en vous servant du verso de cette page. Centrez entre deux chevrons et marquez les trous à découper.

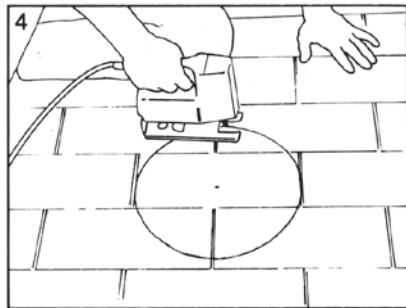

Découpez les trous marqués et scellez autour du haut et des côtés avec du ciment pour toiture.

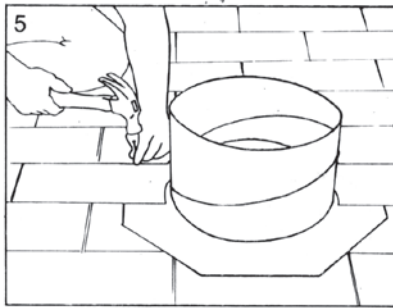

Glissez la moitié supérieure de la bande de recouvrement sous les bardeaux, à fond, jusqu'au tuyau. Appliquez un boudin de 1,2 cm (1/2 po) de pâte à calfeutrage entre le platelage du toit et la surface inférieure de la bande de recouvrement de l'évent. Fixez à l'aide de (12) clous galvanisés à tige annulaire de 31,8 x 9,5 mm (1-1/4 x 3/8 po).

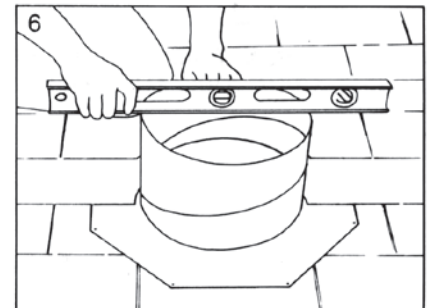

Tournez le haut du collier dans le sens inverse des aiguilles d'une montre, pour arriver à une position de niveau.

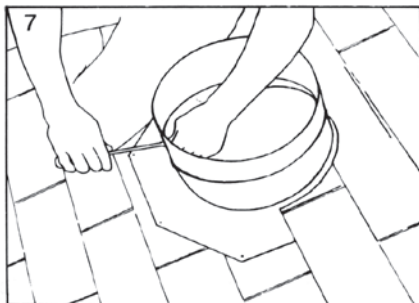

Placaz l'attache de blocage à travers le joint et serrez avec coloré vis mécanique.

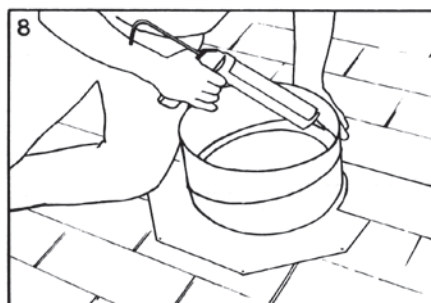

Fixez tout bardeau lâche avec de la pâte à calfeutrage. Scellez tous les joints et clous avec de la pâte à calfeutrage.

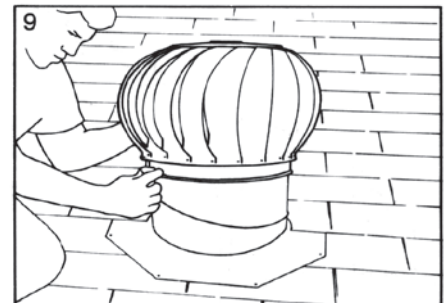

Positionnez la turbine sur le collier, en plaçant les montants verticaux dans les fentes du collier. Posez les vis à tôle n°10 de 25,4 mm (1,0 po) de longueur à travers les montants verticaux et dans les trous à collerette du collier. Serrez les vis fermement mais sans excès pour éviter d'endommager les filets.

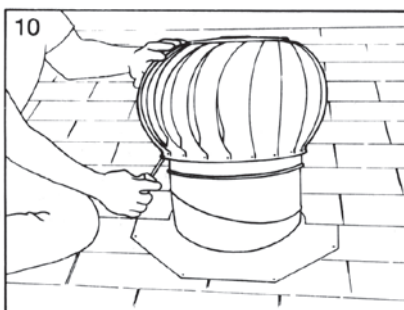

Après avoir complété l'installation, vérifiez pour vous assurer que la turbine tourne librement. Il se peut que la turbine se soit déplacée en cours de transport. S'il y a lieu, soulevez doucement vers le haut le point le plus bas de la turbine afin de supprimer toute oscillation.

OUTILS NECESSAIRES

"Phillips" Tournevis	Règle
Couteau à mastiquer	Niveau de menuisier
Couteau tous usages	Scie passe-partout ou sabre
Foret	Marteau

Ventilador de Turbina Con Base Ajustable

INSTRUCCIONES DE INSTALACIÓN

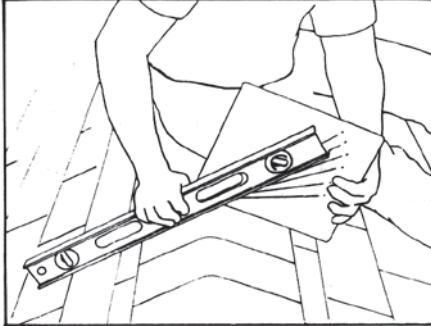

Para determinar la inclinación del techo, ponga el levador en la punta del techo. Ponga el lado opuesto en el techo. Lea la inclinación de la medida del nivel que está paralelo a la línea de abajo.

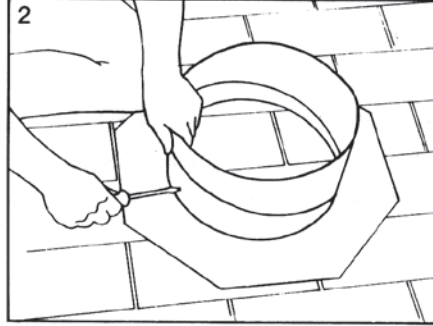

Girar la base del cuello en forma horaria para encontrar la distancia obtenida en la figura 1. Colocar 3 (#10) tornillos por los orificios.

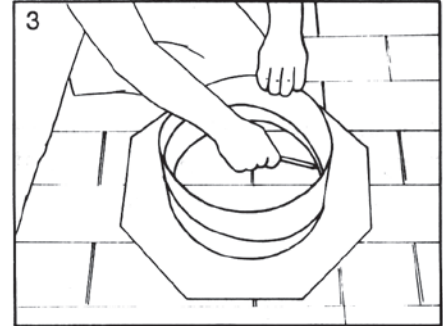

Encuentre la ubicación de la turbina usando el reverso de esta página. Centrar entre las vigas y dibujar el círculo para cortar.

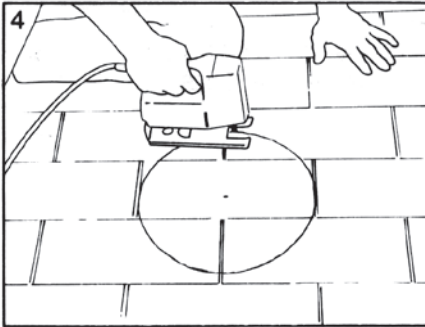

Cortar el orificio por la línea y sellar alrededor del mismo con sellador para techos.

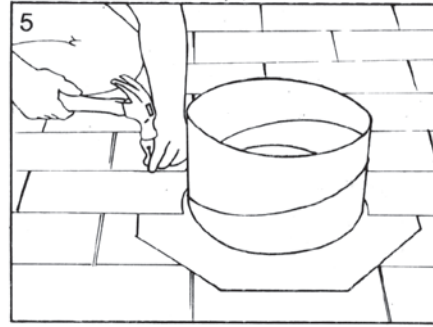

Destlice la mitad superior del panel por debajo de las tabillas hasta el collarín. Aplique una capa de masilla de 1/2" entre la plataforma del techo y la cara inferior de la brida del respiradero. Fije con (12) clavos de vástago anillado galvanizado del 1-1/4" x 3/8".

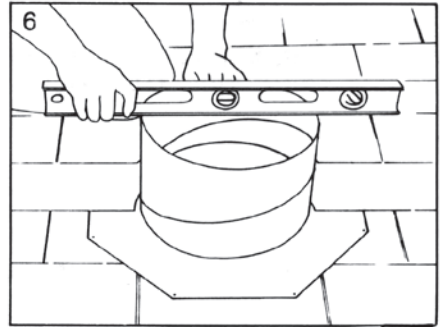

Girar la parte de arriba del cuello hasta que se encuentre en nivel con el techo.

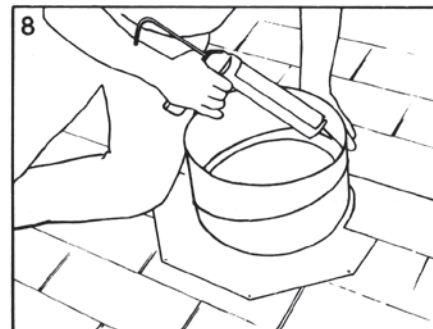
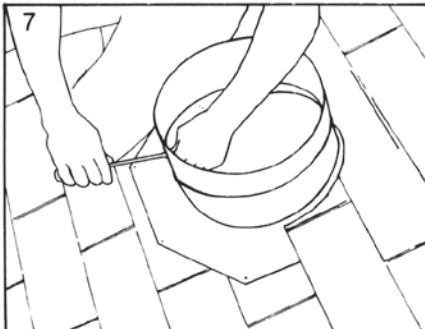

Fije las tabillas que estuvieran sueltas utilizando masilla. Selle todas las juntas y los clavos utilizando masilla.

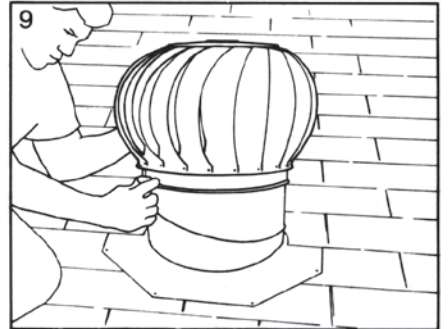

Introduzca la turbina en el collarín, ubicando las patas verticales en las ranuras del collarín. Instale los tornillos de placa de metal #10 1" a través de las patas verticales y hacia los agujeros extruidos en el collarín. Apriete firmemente el tornillo, pero no lo apriete demasiado al punto que se dañe el tornillo.

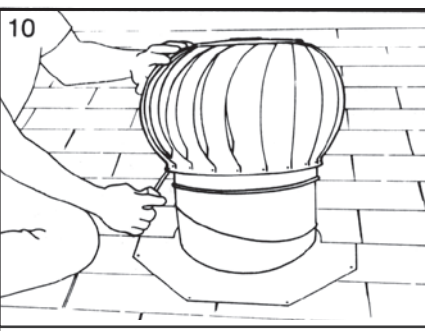

Después de completar la instalación, revise que la turbina gire libremente. La turbina podría haberse doblado durante su transportación. Si fuera necesario, ajuste la turbina doblando desde la parte de abajo.

HERRAMIENTAS QUE NECESITARA:

"Phillips" Destornillador	Taladro
Nivel de carpintería	Martillo
Espátula de masilla	Regla



Choosing the Location of the Turbine Ventilator Choissant la Localisation du Ventilateur de Turbine Elegir la Ubicación del Ventilador de Turbina

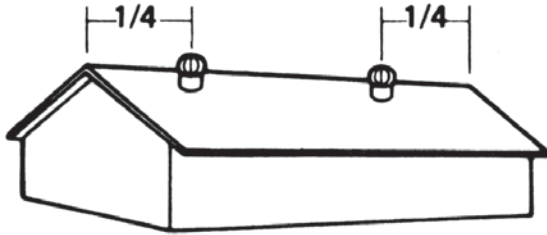

PLACEMENT GUIDE FOR TWO TURBINES
LE GUIDE DE PLACEMENT POUR DEUX TURBINES
LA GUÍA DE COLOCACIÓN PARA DOS TURBINAS

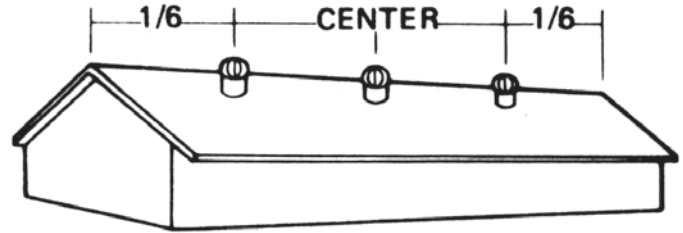

PLACEMENT GUIDE FOR THREE TURBINES
LE GUIDE DE PLACEMENT POUR TROIS TURBINES
GUÍA DE COLOCACIÓN PARA TRES TURBINAS

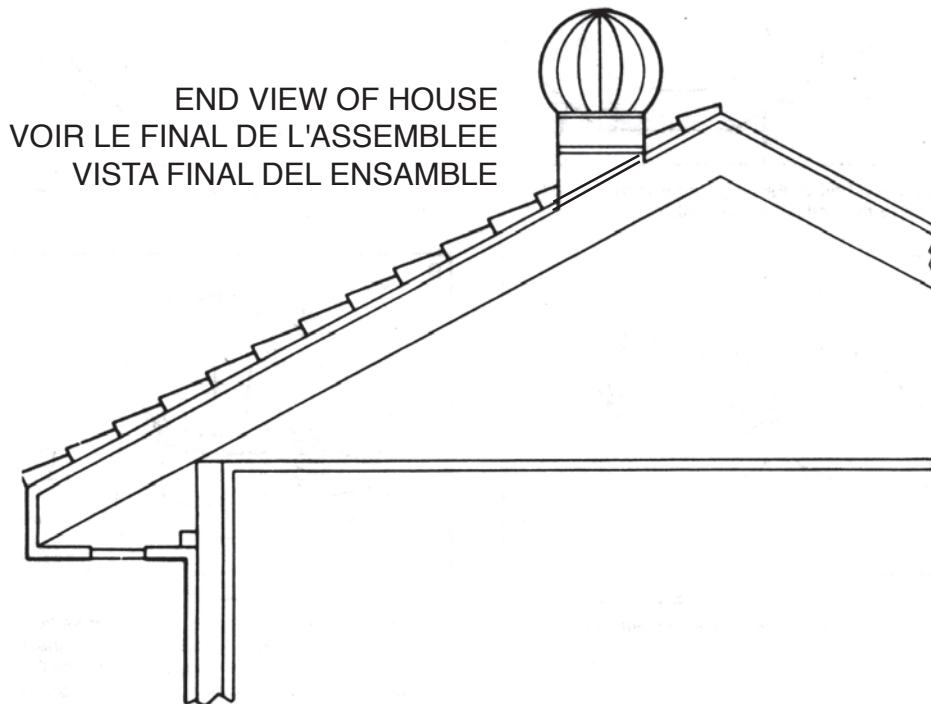

Limited Lifetime Warranty

Air Vent Inc. warrants to the original consumer purchaser of this vent product for the life of the shingles on which it is originally installed that it is sold free of latent defects in materials, parts and workmanship. This warrant is limited to repair or replacement of the defective vent product. All defective products must be returned freight prepaid to Air Vent's factory. If the unit is defective, it will be repaired or replaced, at Air Vent's option, with a new unit free of charge and returned freight prepaid. This warranty does not include repair or replacement due to defects caused by abuse, misuse, fire, substandard or nonconforming installation or destructive weather conditions. This warranty does not cover the labor or any other cost of removal, reinstallation or replacement of, or as a consequence of, the defective vent product. This warranty does not cover field expenses or the cost of any items other than the defective vent product. Consequential damages to property are excluded. Some states do not allow the exclusion or limitation of incidental consequential damages, so the above limitation or exclusion may not apply to you. This warranty gives you specific legal rights, and you may have other legal rights which vary from state to state.